

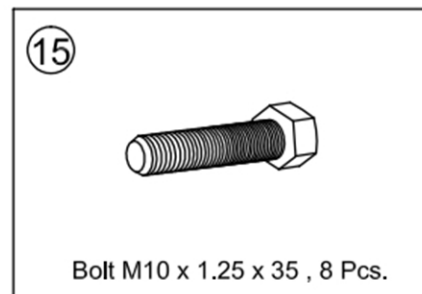

Parts List

Toyota Land Cruiser 300 Series - BW80-4145

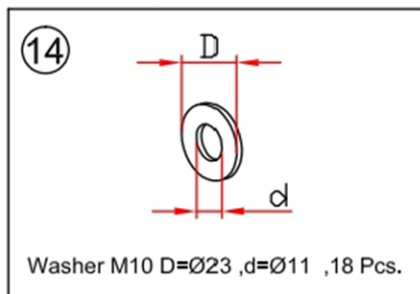

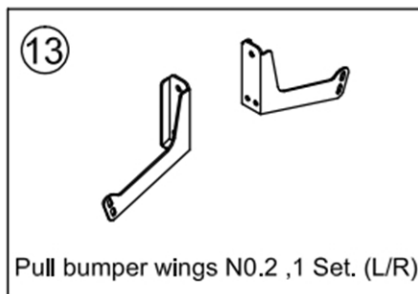
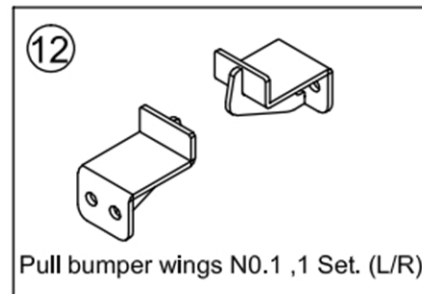
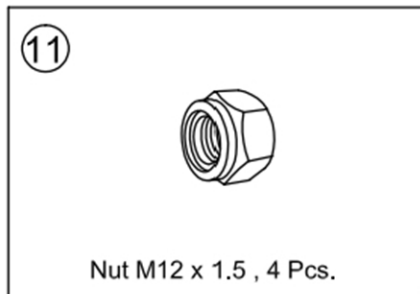
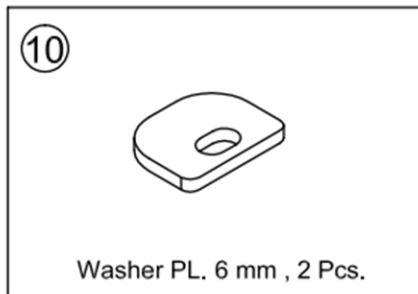
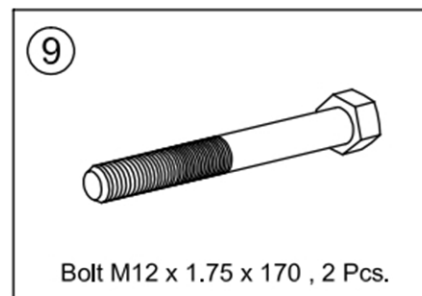
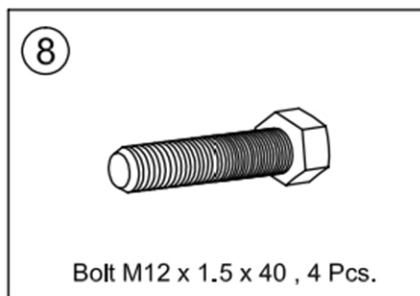
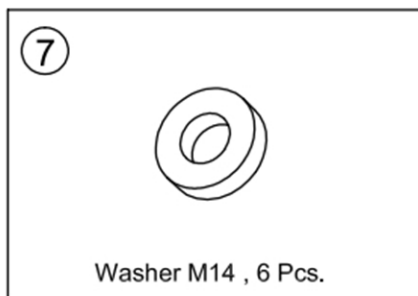
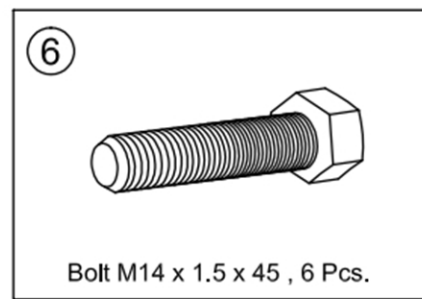
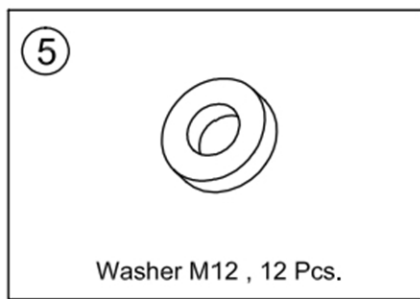
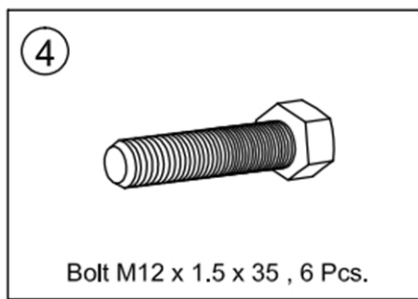
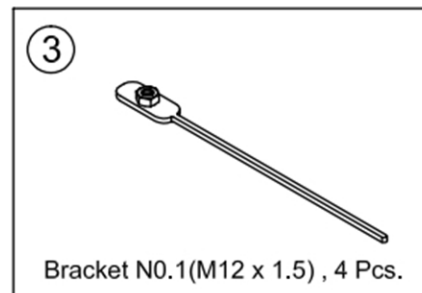
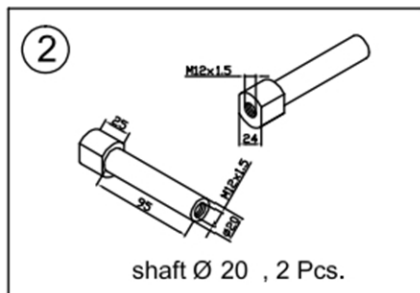
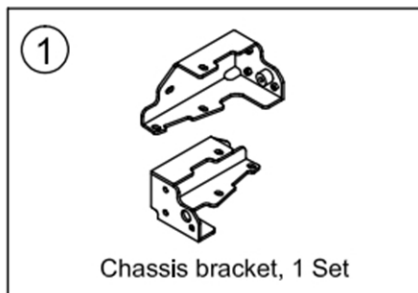

Parts List

Toyota Land Cruiser 300 Series - BW80-4145

16

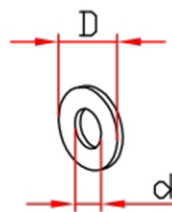

Washer M12 D=Ø45 ,d=Ø13 , 2 Pcs.

17



Bolt M12 x 1.25 x 100 , 2 Pcs.

18



Nut M10 x 1.25 , 8 Pcs.

19

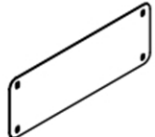

Cover PL. 1.5 mm. , 1 Pc.

20



Bolt M6 x 1 x 20 , 4 Pcs.

21



Nut M12 x 1.25 , 2 Pcs.

22

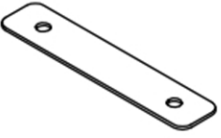

Spacer PL. 2.8 mm. , 2 Pcs.

Detail No.1

