

SUSPENSION

MITSUBISHI PAJERO (2000 ON)

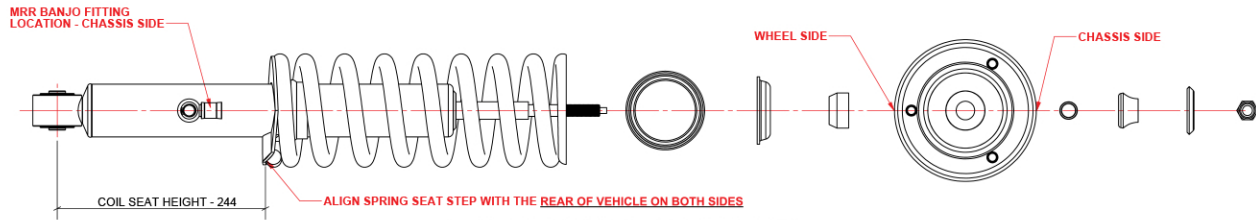

MITSUBISHI PAJERO (2000-ON)
RIGHT HAND STRUT SHOWN

MITSUBISHI TRITON (MQ-MR), PAJERO SPORT (2016 ON)

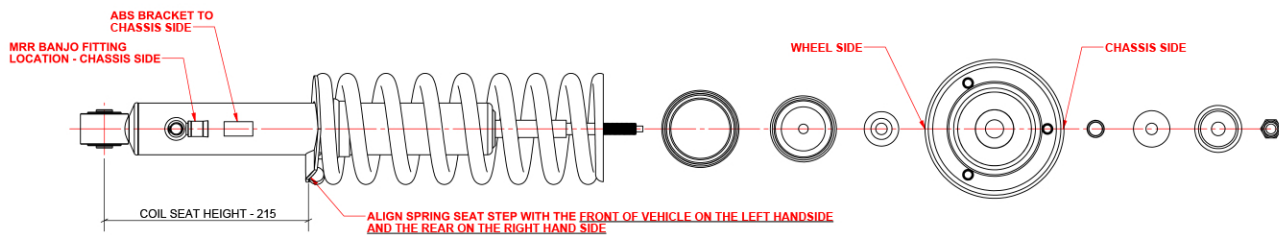

MITSUBISHI TRITON (MQ-MR)
RIGHT HAND STRUT SHOWN

MITSUBISHI TRITON (MN-ML) CHALLENGER (2008-15), PAJERO SPORT (2008-15)

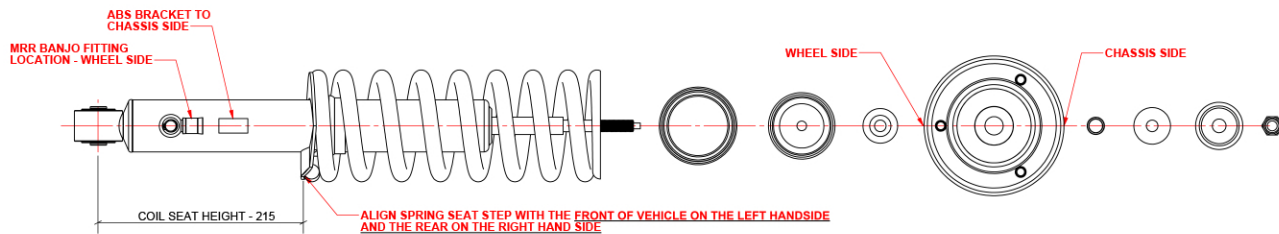

MITSUBISHI TRITON (MN-ML)
RIGHT HAND STRUT SHOWN

TOYOTA HILUX (2005 on)

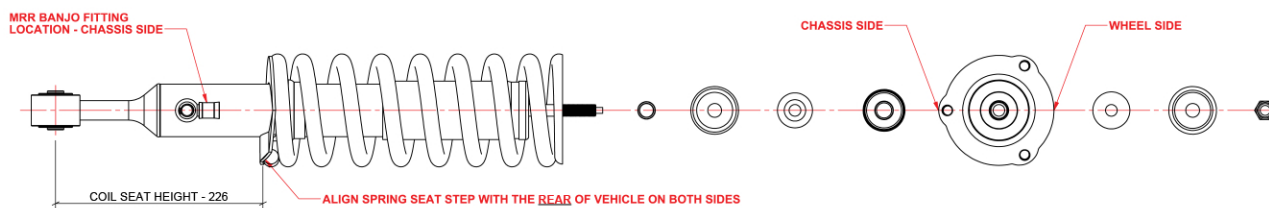

TOYOTA HILUX (2005-ON)
RIGHT HAND STRUT SHOWN

SUSPENSION

TOYOTA LANDCRUISER (PRADO 150) FJ CRUISER / 4 RUNNER (GEN 5)

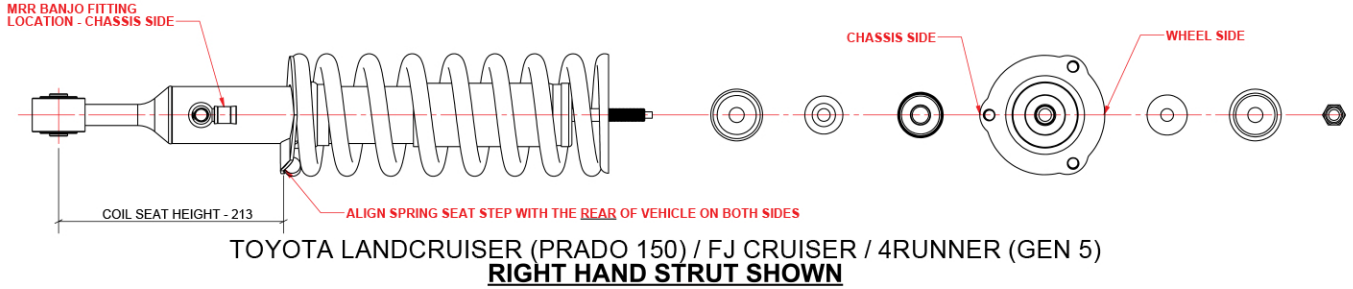

TOYOTA LANDCRUISER (PRADO 120) / 4RUNNER (GEN 4)

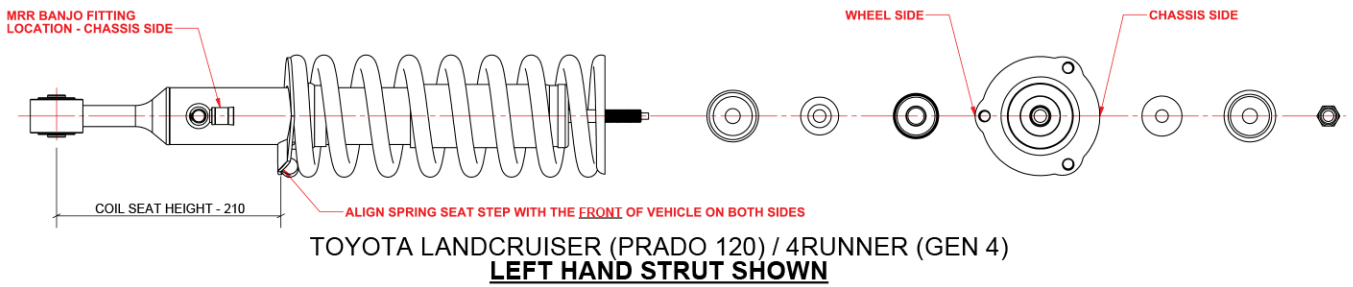

TOYOTA LANDCRUISER (200 SERIES)

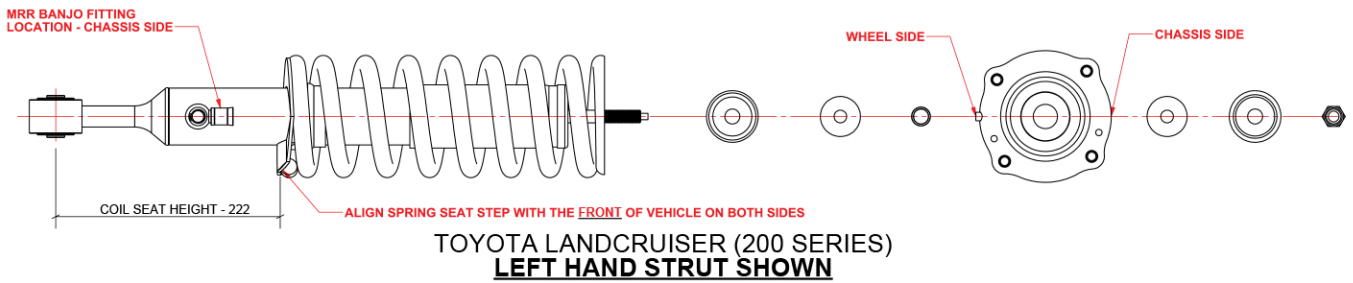

TOYOTA LANDCRUISER (300 SERIES)

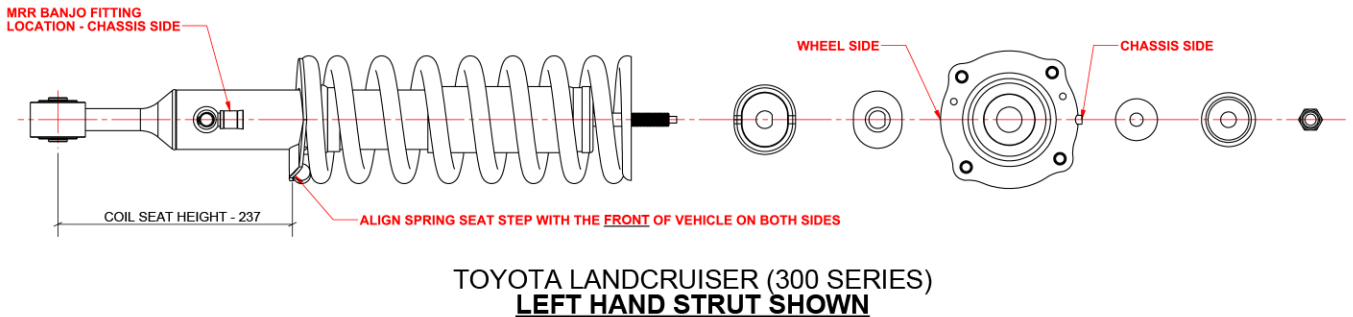

SUSPENSION

TOYOTA LANDCRUISER (PRADO 90)

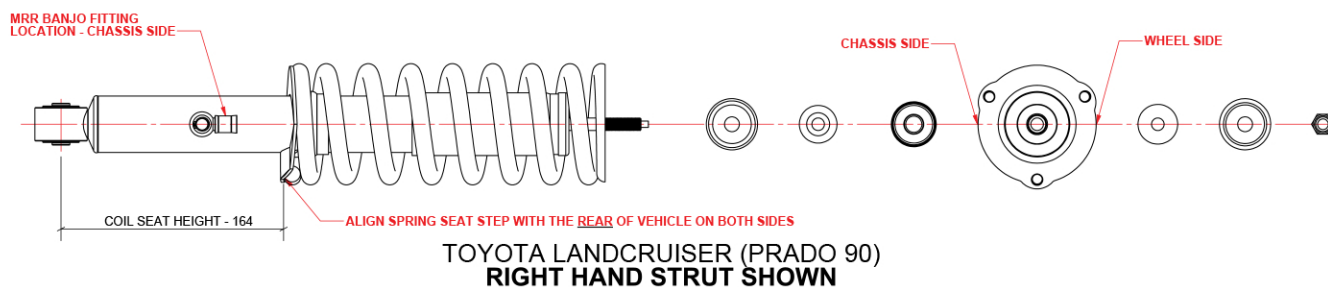

TOYOTA TUNDRA / SEQUOIA 2007-ON

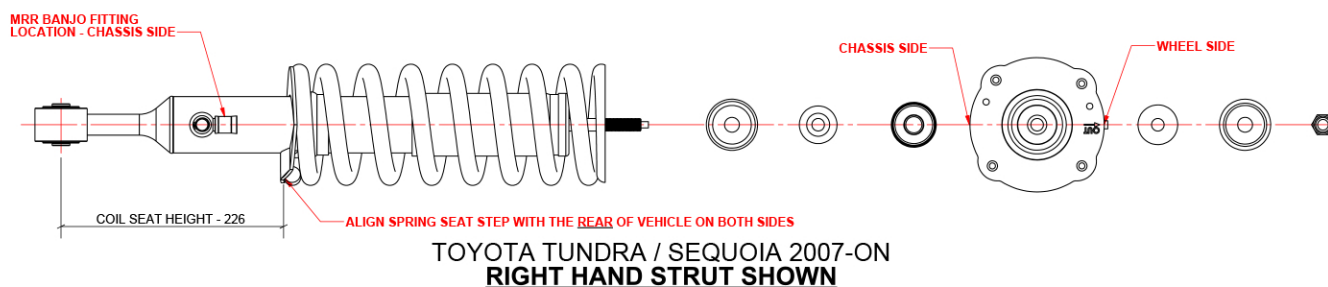

ISUZU DMAX & HOLDEN COLORADO (RG)

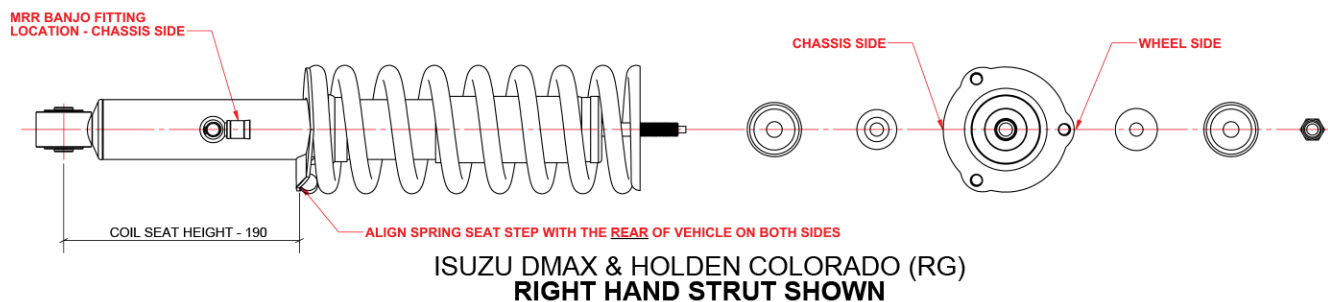

ISUZU D-MAX & MAZDA BT-50 MID 2020-ON

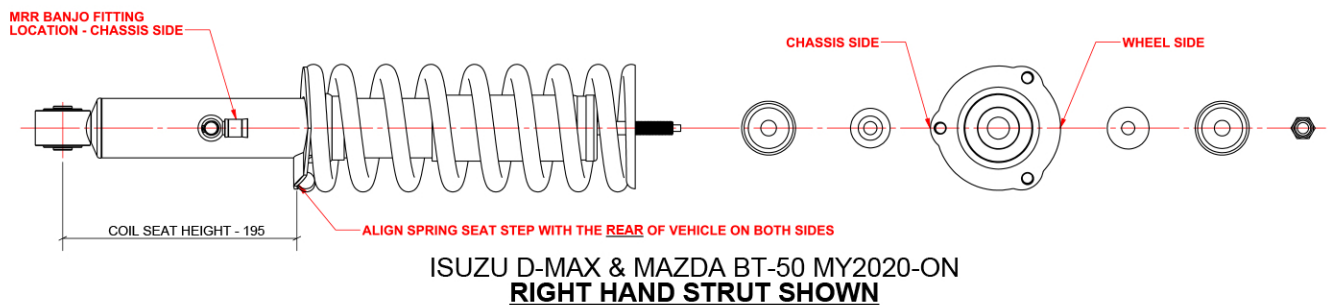

SUSPENSION

NISSAN NAVARA / FRONTIER / PATHFINDER (D40/D23-NP300/R51)

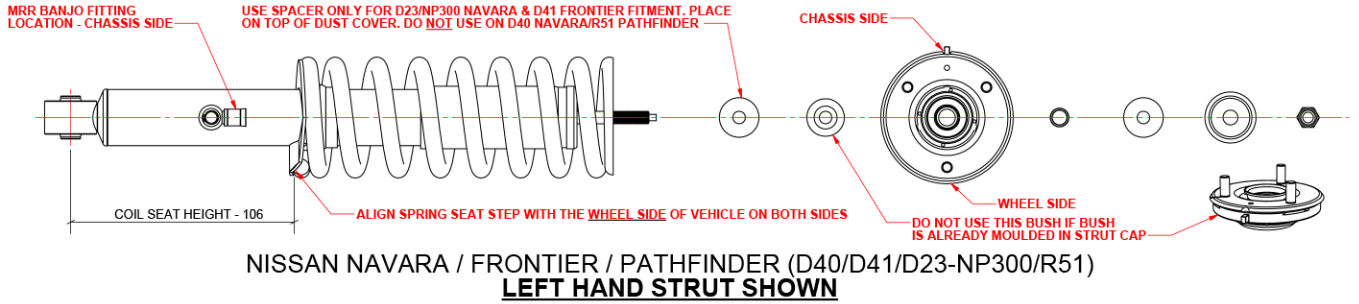

MAZDA BT50 & FORD RANGER PX 1 & 2

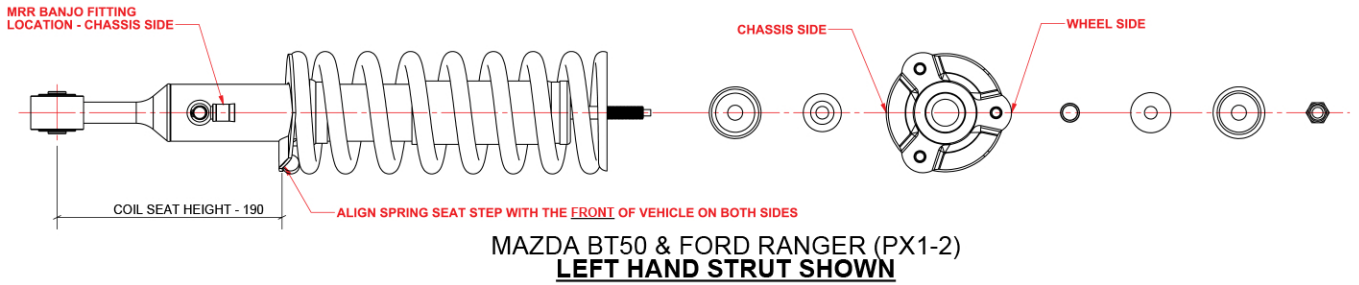

FORD RANGER PX3

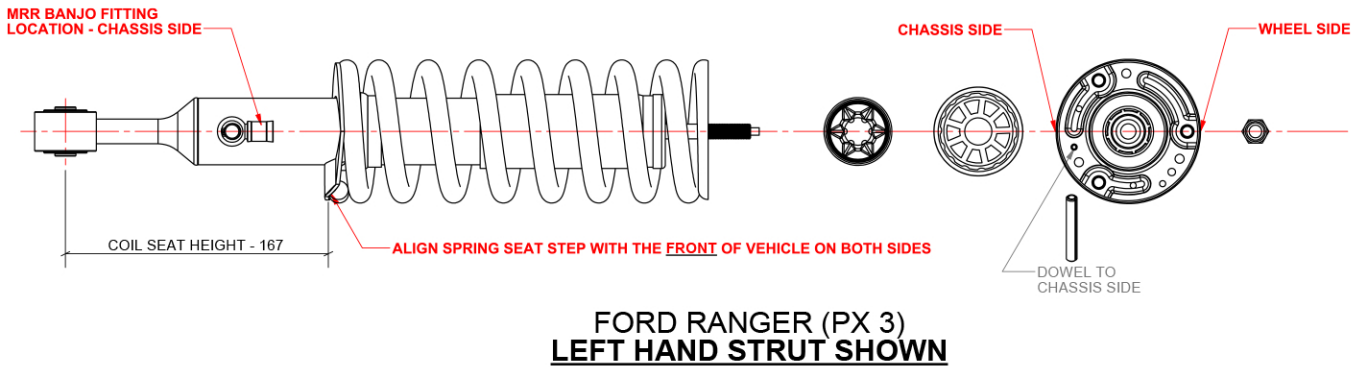

FORD RANGER NEXT GEN / PU

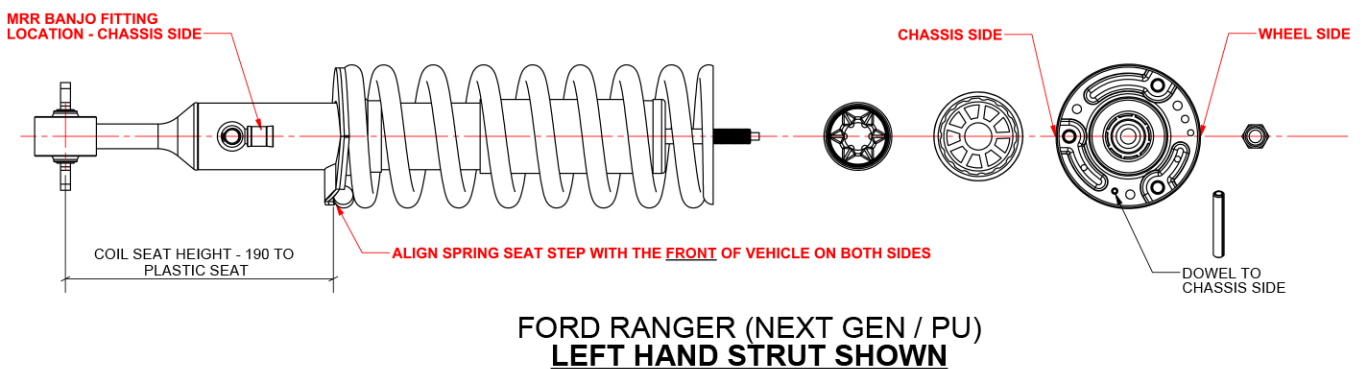

SUSPENSION

VOLKSWAGON AMAROK

